

Menü

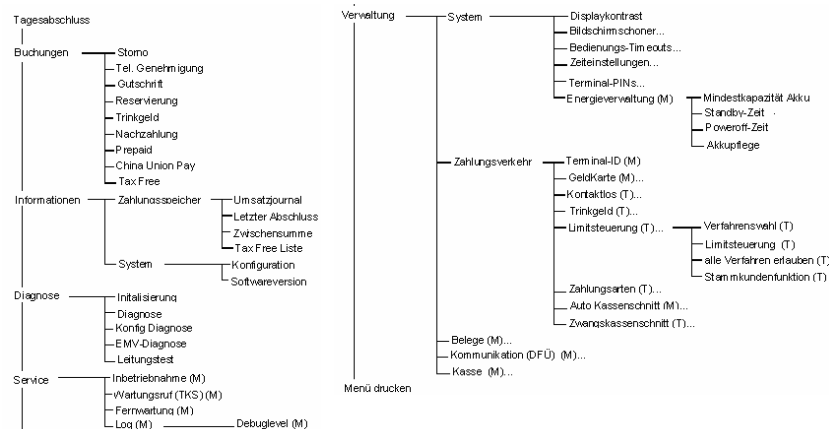

Kassierer-PIN
Manager-PIN
Techniker-PIN

Der Menübaum kann über das Terminal-Menü ausgedruckt werden („Menü“)



Favoriten



Nach Drücken des Softkeys „Favoriten“ wird eine Auswahl der folgenden Funktionen angezeigt:

- | | | |
|-------------------------------|-------------------------|----------------------------|
| Belegwiederholung | Gesamtumsatz | Reservierung |
| Buchung Erstreservierung | Gutscheinkarte | Status-Kassenschnitt |
| Cashback | Gutschrift | Storno |
| CUP (China Union Pay) | Inbetriebnahme | System-Informationen |
| DCC (Dyn. Währungsumrechnung) | Initialisierung | Tax Free |
| Diagnose | Kassenschnitt | Telefonische Autorisierung |
| EMV-Konfigurationsdiagnose | Konfigurations-Diagnose | Trinkgeld |
| Fernwartung | Menü-Aufruf | Umsatzjournal |
| Funktionsnummer | Nachzahlung | Wartungsruf (TKS) |
| GeldKarte | Prepaid | Zwischensumme |

Hotline:

Terminal-ID: _____

VX680 GPRS VX680 WLAN

www.ccv-deutschland.de



Kurzbedienung

Terminal einschalten

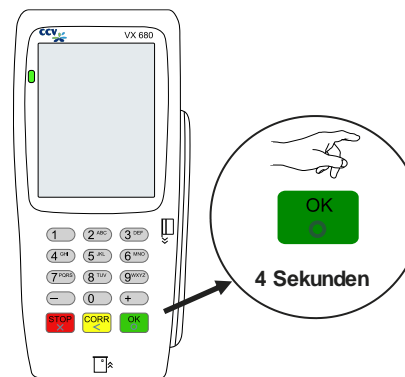

Terminal ausschalten

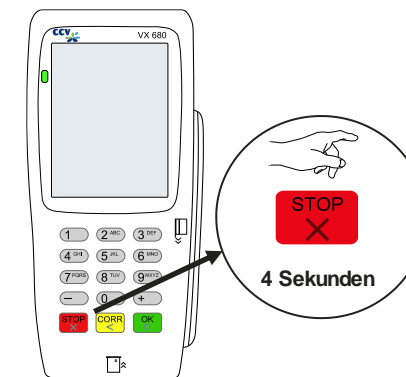

Akku laden

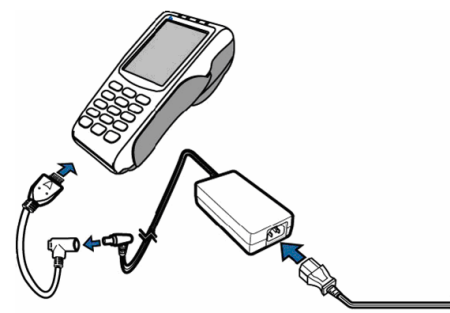

Bonrolle einlegen

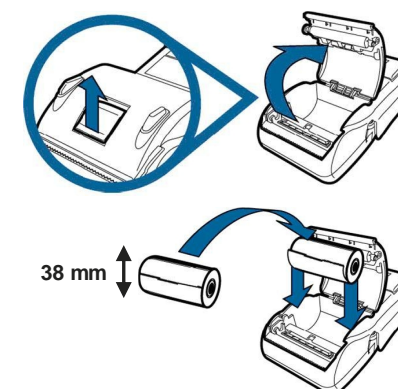

Grundzustand



- Statusleiste** (Akku, Uhrzeit, Kommunikationsinfo und Signalstärke)
- Betragseingabe** (mit zwei Nachkommastellen eingeben
Beispiel: Eingabe 5000 für 50,00 €)
- Softkey-Funktionen** (Storno, Trinkgeld, Tagesabschluss, Gutschrift, Belegwiederh., Favoriten)

Tagesabschluss

1. Funktion Tagesabschluss *	2. Beleg kontrollieren		
 + 			

*Im Falle vorh. GeldKarten-Umsätze erfolgt im Anschluss an den Kassenschnitt die GeldKarteneinreichung.

Karte einlesen

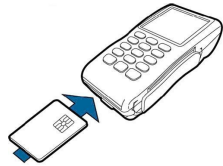

Chip-Karte stecken
(Chip nach oben)



Magnetstreifen-Karte zügig durchziehen
(Magnetstreifen links unten)







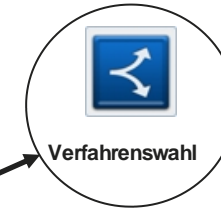

Kontaktlose Karte
- auf das Display legen
- Abstand kleiner 4 cm
- bitte die Statusanzeige im oberen Displaybereich beachten

Verfahrenswahl (optional)



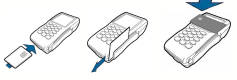

Sofern freigeschaltet, kann das Zahlungsverfahren im Zuge der Zahlung gewählt werden
(Bildschirm „Karte bitte“ —>Symbol zur Verfahrenswahl —>Auswahl der erlaubten Verfahren).





Zahlung

1. Betrag eingeben	2. Karte einlesen (Chip-, Magnet- oder Kontaktlos-Karte)	3. PIN-Eingabe (opt.) und Bestätigung	4. Beleg kontrollieren
 + 		 + 	

Umsatzinformationen

Funktion Status-Kassenschnitt	oder Umsatzinformation über Menü	
	  Menü-PIN	Informationen/ Zahlungsspeicher —>Umsatzjournal, letzter Abschluss oder Zwischensumme

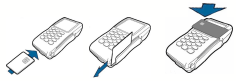
Storno

1. Funktion Storno	2. Transaktionsnummer eingeben	3. Karte einlesen (Chip-, Magnet- oder Kontaktlos-Karte)	4. PIN-Eingabe (opt.) und Bestätigung
	 + 		 + 

Initialisierung/ Diagnose

1. Funktion Initialisierung bzw. Diagnose	2. Beleg kontrollieren		
 bzw. 			